



Electric examination couch
SIMPLEX range
SIMPLEX-2.0

CARINA
Medical



CE
ISO 9001
ISO 13485

TECHNICAL DETAILS

- 2 sections examination couch, width 60cm
- Control : Pedal
- Backrest adjustment in every positions with gas jack
- Flat upholstery with good density 24kg/cm², M1 fire retardant class, thickness 6cm
- Equipped with paper roll holder for exam sheet, on the foot side
- Epoxy covering, silver colour

DIMENSIONS

- Width 60cm
- Adjustable height from 56 to 86cm
- Load capacity : 150kg in dynamic

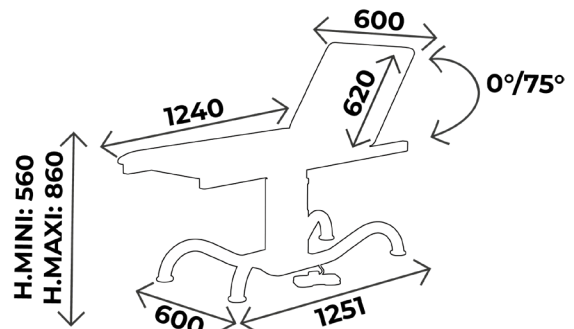

You may also like :

Ref. **SIMPLEX-2.0-700** : Same as SIMPLEX-2.0 but width 70cm



WHAT YOU NEED TO KNOW

- ✓ Delivery time: 15 days upon receipt of order
- ✓ Warranty : 2 years (1 year for the upholstery)

ACCESSORIES



ACC 990-SIMPLEX
Set of 4 wheels with brake
diam. 75mm



ACC 76C
Unit clamp to fix infusion stand
diam. 16mm



ACC 110
Blood test splint in colour
without clamp, the unit

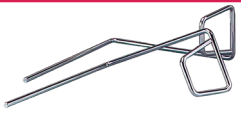

ACC 105
Pair of stainless steel stirrups
diam. 14mm, without clamp



SLFEMIREPOSE
Cover for legrests (ACC964)
in upholstery, the unit

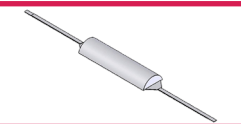

ACC 54001
Half moon head rest width 60cm
fire retardant M1 class



ACCURGENCE03-60
Pair of retractable security side
rails for SIMPLEX couch
width 60cm



ACC 832
Face hole with plug cushion



ACC 538
Pair of clamps diam. 14mm for
SIMPLEX range width 60cm



ACC 32012
Stainless steel infusion stand
diam. 16mm, 2 plastic hooks,
without clamp



ACC 110POLY
Polyurethane blood test splint
without clamp, the unit



ACC 964
Pair of legrests on knee system
in black polyurethane
diam. 14mm, without clamp



ACC 514-UNIVERSE
Plastic protection cover
for all couches



ACC TETERGO
Ergonomic head rest



ACC BARRILITCOM
Pair of retractable security side
rails

UPHOLSTERY'S COLOURS

Fire retardant
upholstery, M2 class

For the upholstery colours, you can choose between the Ecomax, Classic and Urban range
Be careful ! Classic and Urban colours **with extra value**

Upholstery : ECOMAX range*



Galapagos Bahamas Blanc



Tahiti Malouines

*Standard colors for ECOMAX and SIMPLEX range,
Classic and Urban colors **on demand**



UPHOLSTERY'S COLOURS

Fire retardant
upholstery, M1 class

For the upholstery colours, you can choose between the Classic and Urban range
Be careful ! Classic and Urban colours **with extra value**

Upholstery : Classic range



Arno



Garonne



Potomac

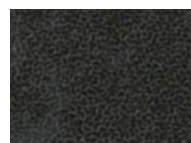

Amour

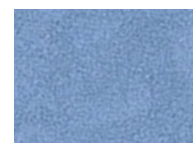

Mississippi

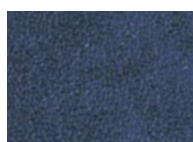

St Laurent



Rhône

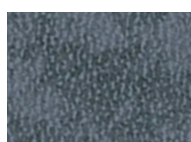

Missouri



Seine

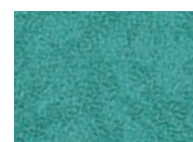

Amazone

Upholstery : Urban range



Abysses



Cendre



Origan



Géranium



Régilisse



Prune

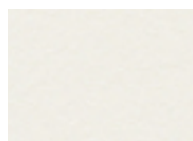

Perle

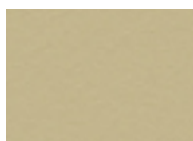

Ficelle

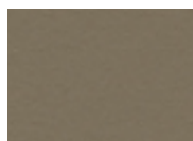

Terre

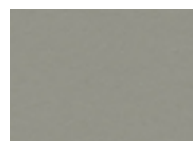

Béton

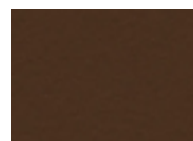

Chataigne

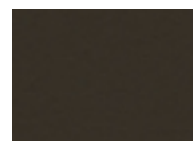

Chocolat

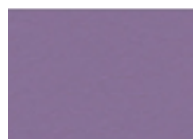

Pensée



Pétrole



Turquoise



Granny



Absinthe



Ananas



Orange



Fuschia



Tomate



MAINTENANCE GUIDE

DAILY MAINTENANCE

Upholstery : Cleaning with soapy water only (no solvents), can be disinfected with products such as Phagosept Spray, Salvanios pH10 at 0.75% and Anios Surfaces Hautes, without abrasive material

Base : cleaning with soapy water only (no solvents) without abrasive materials

WARRANTY

Mechanical/ electrical part : 5 years

Upholstery : 1 year



CONTACT

CARINA
Medical

Parc d'entreprises Visionis
278 rue de l'industrie
01090 GUÉREINS- FRANCE

COMMERCIAL DEPARTMENT

Tél : +33(0)4 74 66 69 49
Fax : +33(0)4 74 66 69 50
export@carinamedical.com